

# Managing Building Design Variants at Multiple Development Levels

Hannah Exner<sup>1,\*</sup>, Jimmy Abualdenien<sup>1</sup>, Markus König<sup>1</sup> and André Borrmann<sup>2</sup>

<sup>1</sup>Chair of Computing in Engineering, Ruhr University Bochum, Germany

<sup>2</sup>Chair of Computational Modeling and Simulation, Technical University of Munich, Germany

\*email: [Hannah.Exner@ruhr-uni-bochum.de](mailto:Hannah.Exner@ruhr-uni-bochum.de)

## Abstract

The development and investigation of design variants at early planning phases represents a challenging task including a high variety of interests and objectives which need to be considered. The principles of Building Information Modeling (BIM) offer new prospects by representing a valuable input for simulation and analysis tasks. During the design process, experts from different disciplines frequently exchange building information to iteratively develop a design that satisfies the project's individual requirements. In this context, different variants need to be developed which evolve throughout multiple refinement stages. The maturity of the design information provided by an explicit model is expressed by the notion of Level of Development (LOD). However, the available LOD definitions are informal, do not include the information uncertainty, and incapable of representing the overall building model. This can lead to false assumptions and model evaluations that affect the design decisions made during the design stages. Therefore, we propose a new concept, Building Development Level (BDL) for describing the maturity of the overall building model and a multi-LOD meta-model to formally define and maintain multiple BDLs and incorporating the potential uncertainties. At the same time, a graph-based representation of the building model and related variants are proposed to avoid duplications and inconsistencies between the single design variants which are developed in early planning phases. The paper is concluded with a case study representing the design process of an office building including variants at different BDLs.

**Keywords:** BIM, LOD, Design Management, Early Design, Graph Data Models, BDL

# 1. Introduction

The design of a building is a complex process that involves considering multiple interdependencies and restrictions. Various domain experts with different backgrounds and interests need to be included in the process to fulfill the diverse restrictions and requirements (Chiu, 2002). At the early planning phases, the designer develops multiple design variants as solutions fulfilling the client's requirements and external regulations (e.g., building codes or technical and environmental aspects). While decisions at early phases show a significant influence on the building life cycle, the management of the early design stages is critical to circumventing a substantial amount of rework (Ballard & Koskela, 1998), increased costs, and reduced productivity (Kolltveit & Grønhaug, 2004). The decision whether a design variant is neglected or detailed further is often based on domain-specific simulations, analyses or recommendations. Designs might be assessed regarding various performance criteria including energy consumption and costs. In this case, the domain expert also requires a minimum set of information, which might not be directly provided by the designer. In case the designer or client is not able to add the missing information, the domain expert makes suggestions or assumptions.

Figure 1 illustrates the above-described collaboration between several actors in the design process. At every stage, involved disciplines require specific information to perform (model) analyses. Additionally, architects incorporate the clients' feedback and engineers' analyses result into the building models and subsequently, develop design variants.

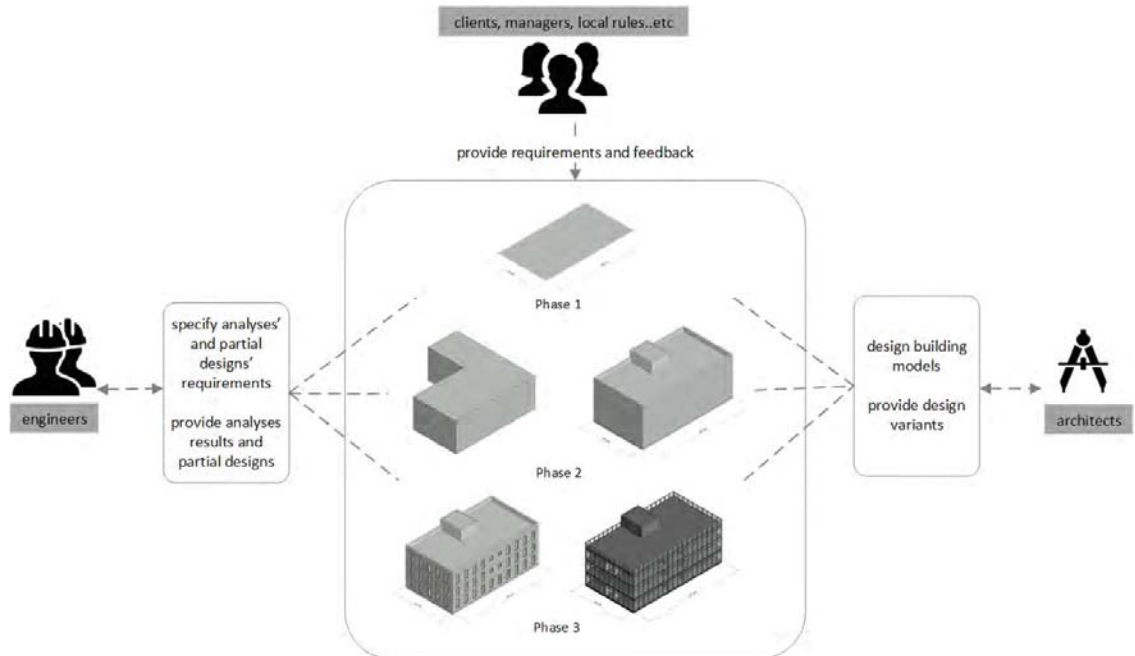

Figure 1: Collaboration between several disciplines to define a building project's requirements and objectives

As building projects are highly individual projects including complex interdependencies between decisions, early design phases may require assumptions and approximations. To achieve consistent models, these assumptions need to be integrated into the building model. The added information might be described by either discrete values or uncertain parameters.

Throughout the design phases, the building model is gradually refined from a rough conceptual design to highly detailed individual components. The Level of Development (LOD) describes the sequential refinement of the geometric and semantic information by providing definitions and illustrations of BIM elements at different phases of their development. At the same time, design variants are created to find suitable solutions for the given project requirements. The decision between design variants usually takes place between two successive planning stages. Subsequently, the preferred variant is detailed

further, and new variants might be developed.

As the focus in the early stages is on the organization of the building as a whole, considering various functional and interrelated entities, it is essential to follow clear guidelines in describing the expected elements to be present in the building model as well as their maturity, i.e. LOD, at a particular stage. The LOD concept represents the individual elements; however, when comparing design variants by analyses and simulations, it is crucial to describe the overall building model and its refinement, including the available elements and their information. However, numerous variations of the LOD concept exist and have caused a large degree of confusion (Bolpagni, 2016). The authors of the BIMForum specification have confined their LOD definitions to describe the maturity of the elements inside the building model. This means that it is not applicable to describing the overall building maturity, which is what the BDL concept addresses; in their words:

"There is no such thing as an 'LOD ### model.' As previously noted, project models at any stage of delivery will invariably contain elements and assemblies at various levels of development" (BIMForum, 2019).

Therefore, we introduce a new concept, *Building Development Level (BDL)* (Abualdenien & Borrman, 2019), to describe the overall building refinement in five levels (BDL 1 - 5), as described in Figure 2:

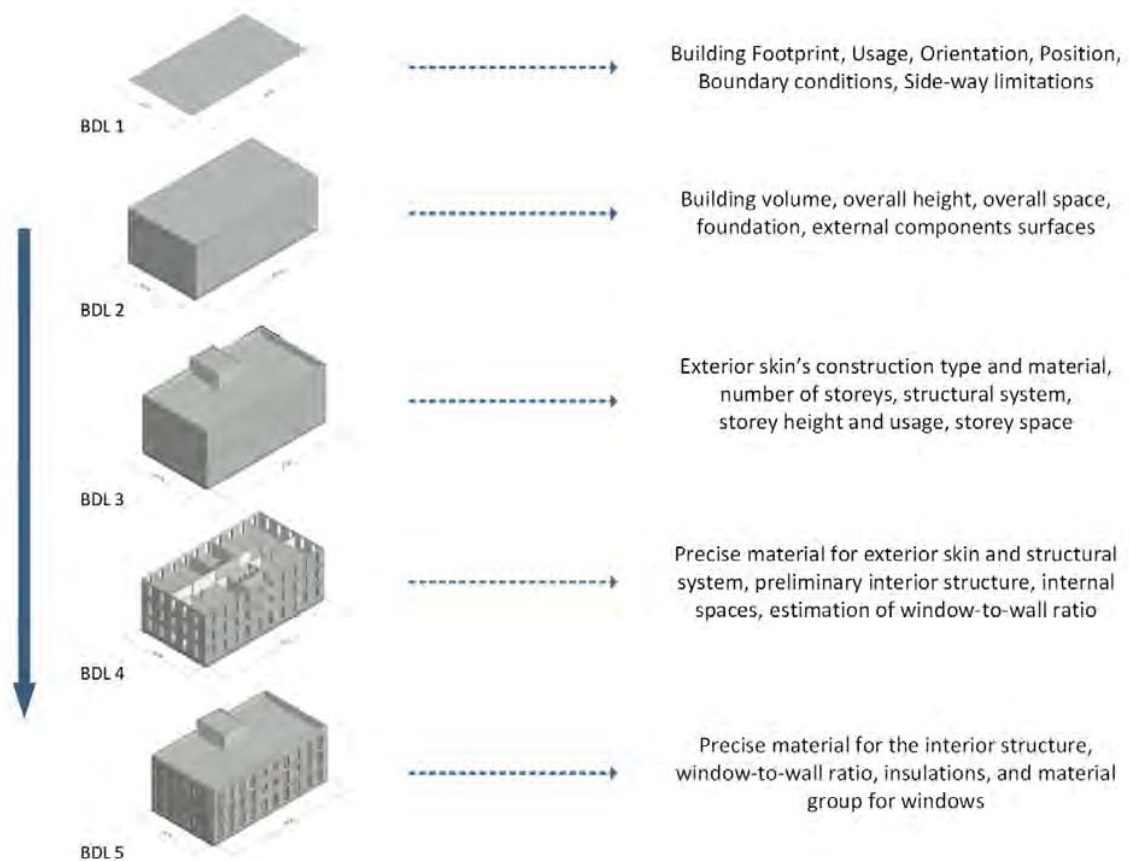

Figure 2: Design development from BDL 1 to BDL 5 (Abualdenien & Borrman, 2019)

## 2. Objective

During the iterative planning process, an individual building evolves throughout multiple refinement stages. In parallel, different variants are developed. In order to manage design variants at multiple BDLs, graph-based representation of the building model and related variants is proposed to avoid duplications and inconsistencies between the single designs. In contrast to the conventional method of

creating a single model for each design variant, the existing IFC data model, which is an internationally recognized open data model for BIM, is expanded by „option objects” to cover multiple design variants. Following this approach, redundant and inconsistent building elements are avoided, and the design development of a building becomes traceable. As the vendor-free IFC data model does not support the notion of LOD or a description of its uncertainty, it can be shown how an external meta-model can be used to enrich IFC data by these aspects.

The model's maturity is described by the newly developed BDL concept, which describes the maturity of a whole building model as well as the available building elements and their expected level of development. The BDL of a design variant is strongly dependent on the available amount of information, contained elements and the effort needed to add details to the design. At any decision point, the results need to be verified for not contradicting with BDLs at earlier phases. The aim is to maintain developing consistent models without any information loss or contradictions.

### 3. Methodology

#### 3.1 Consistent Management of Design Variants

The main intention of the variant management concept is to manage design options in a consistent and redundancy-free model. Furthermore, the relation between single variants and their influence on the subsequent planning phases should be traceable. By basing the concept on the widely adopted and standardized data model 'Industry Foundation Classes' (IFC), the concept's applicability is increased as IFC are integrated into a growing number of software products (buildingSMART International, 2016).

The use of Graph Data Models (GDM) is proposed to increase transparency and traceability. GDM enable to clearly describe and store multiple variants as well as extract single model instances from the database despite the growing number and complexity of design variants, which can be observed during the planning process.

A transparent graph-based realization of the (IFC) data model is implemented by translating project elements into nodes (N) and relationships between objects as links (L) between elements (see Figure 3).

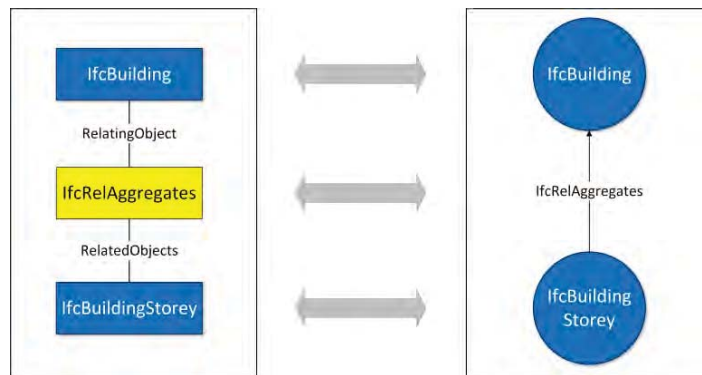

Figure 3: Mapping of classes and relationships

Subsequently, classes and relationships are defined to implement variants. As the current version of the IFC standard (IFC 4) does not support the management of variants, required classes and relationships are added as new entities to the schema as presented in Mattern & König, 2017 (see Figure 4).

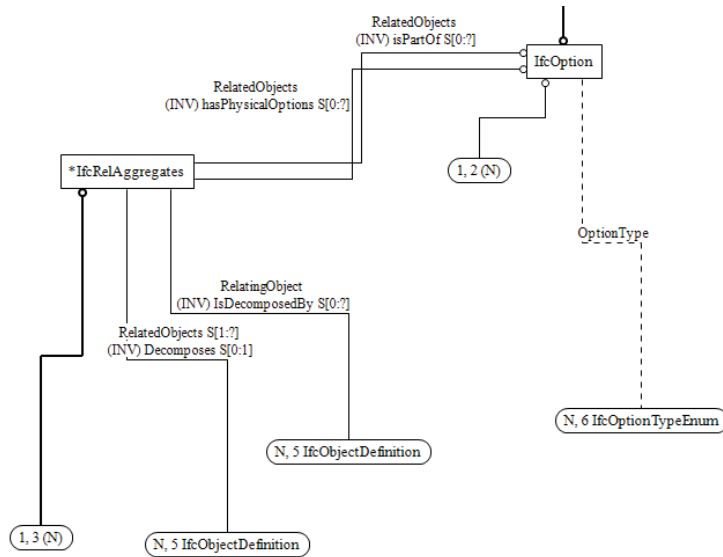

Figure 4: Expansion of the existing IFC4 Express schema to include variants

Figure 5 shows the application of the concept as described in Mattern & König, 2018. The “Option Manager Tool” was developed to store single models to a graph database. An upload to the graph database is only conducted after having passed a consistency check of the models concerning criteria like an identical project, units, location or project phase. In the event of inconsistencies, the designer is informed and adjusts the models correspondingly. Afterward, the designer manually defines the single variants which are relevant for the project at the given project phase. The Option Manager Tool checks for identical objects before creating the consistent model integrating all defined variants in the database. From this point on, the exchange is based on an extended version of IFC which supports multiple options (see Figure 4).

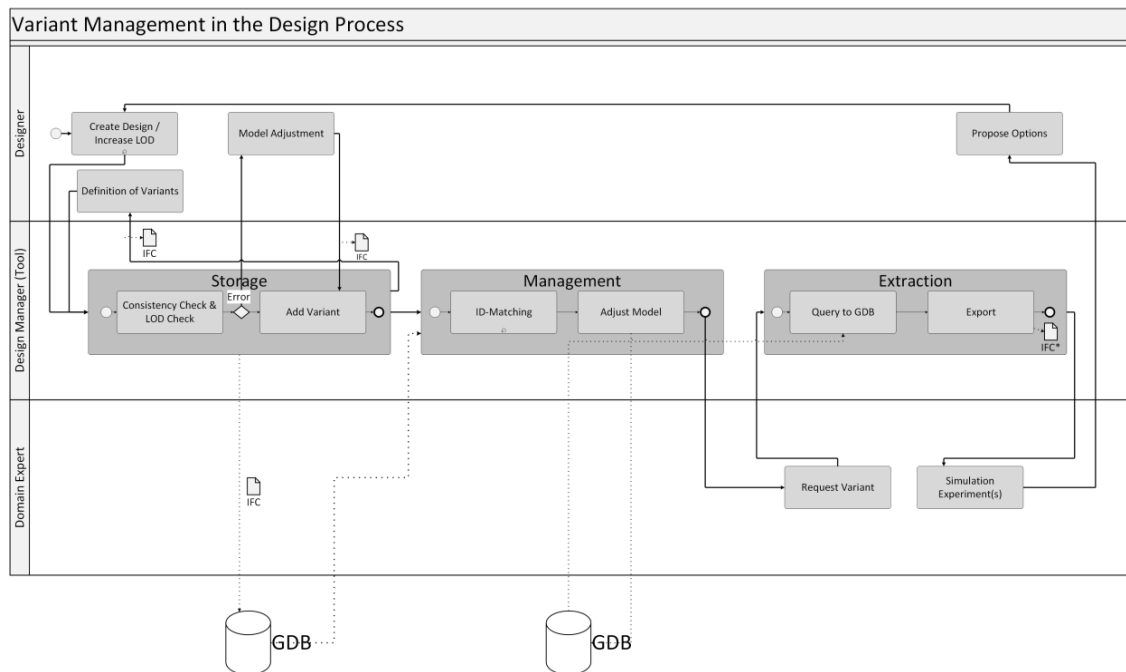

Figure 5: BPMN diagram: Possible usage of the developed framework in building design according to Mattern & König, 2018

### 3.2 Consistent Management of Multiple BDLs

A major challenge for using BIM-authoring tools in the early design stages is that despite the insufficient information available in these stages, a BIM model appears precise and certain, which can lead to false assumptions and model evaluation. Additionally, although the Level of Development (LOD) (BIMForum, 2019) is a well-known concept that describes the quality and quantity of the information contained within a BIM model, the currently available specifications are informal, textual descriptions and graphical illustrations.

Knowing when a building model is at a specific BDL is important as it represents a milestone for performing new tasks using newly defined information. Currently, the model-based planning techniques lack the support of managing multiple levels of development, in particular, a description of geometric-semantic information's uncertainty. Existing LOD definitions are informal and imprecise, only textual and graphical, leading to multiple interpretations regarding the expected information at each level. However, this knowledge is crucial for the model assessment, since its absence can lead to false assumptions, which affect the design decisions taken throughout the design stages.

The main idea of describing the LODs' and BDLs' refinement throughout the project's lifecycle is the attempt to represent and formalize the model maturity, either by explicitly defining relationships or by controlling the amount of added details within a BDL, which makes it possible to check the model's consistency. Currently, there is no approach for formally defining and maintaining multiple BDLs as well as incorporating its information uncertainty. The developed building models throughout the design stages are decoupled and appear detailed as well as certain, even in the early stages. This can lead to false assumptions and model evaluations that affect the design decisions made throughout all design stages. For this purpose, we propose a multi-LOD meta-model that facilitates a formal specification of the LOD definitions, incorporating the component types' attributes vagueness. Accordingly, the information provided as an input for the different types of simulations and analyses can be estimated earlier by representing it as a range of values and a distribution function or an abstract classification rather than a fixed value.

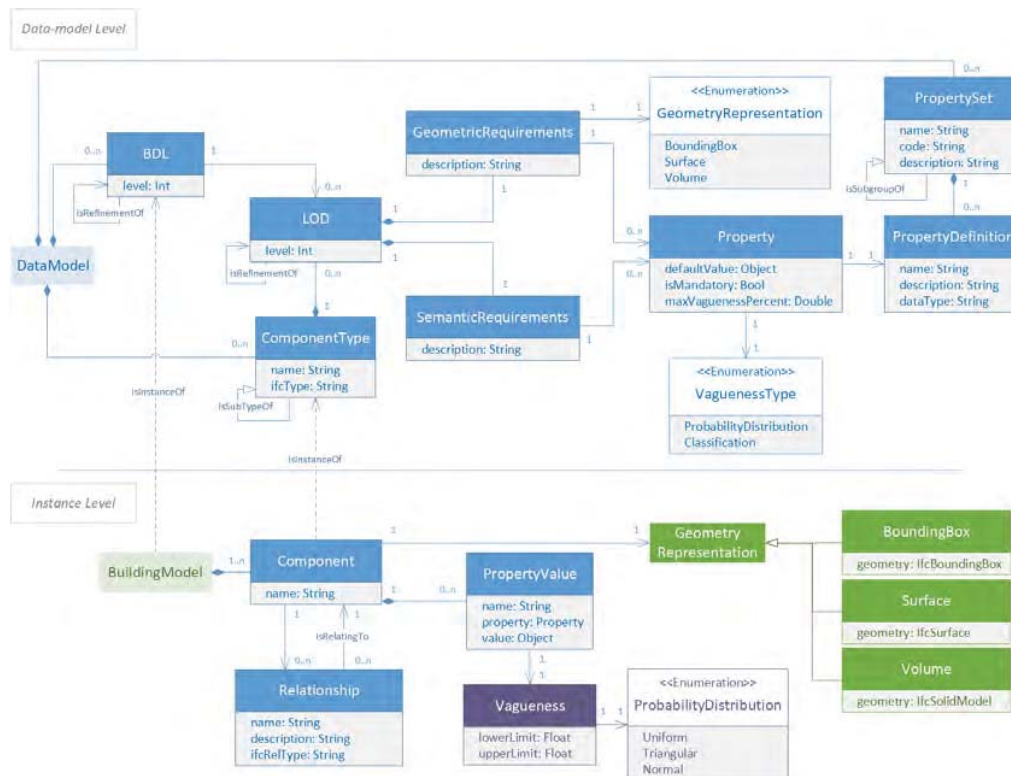

Figure 6: Multi-LOD meta-model (UML diagram)

As illustrated in Figure 6, the meta-model consists of two layers: (1) the *data-model level* to define the component types' LOD requirements, and (2) the *instance level* to represent the actual building components as well as their relationships. The data-model level facilitates the definition of various component types, such as *wall*, *window*, and *slab*. Each component type is associated with multiple LOD definitions and linked to an Industry Foundation Classes (IFC) (buildingSMART International, 2016) class, which makes it possible to use the rich geometry representations and test with real-world building models. An LOD definition includes a geometry representation, *BoundingBox* as an example, as well as geometric and semantic properties, which are assigned to a vagueness type and maximum percentage. The explicit specification of vagueness to the LOD requirements facilitates a model's analysis and supports informed decision-making in the early design stages. The instance level, on the other hand, represents the building components and maps their properties as well as geometry representation to the requirements defined at the data-model level.

Besides communicating the information vagueness to the project's participants, a major benefit of defining the requirements at the multi-LOD meta-model is to formalize the vague input used by the different analysis tools. Accordingly, the domain experts collaborate to alleviate the impact of the information vagueness.

Figure 7 illustrates the data-model level of an external wall at LOD 200 and 300. The geometric requirements include the *height*, *width*, and *thickness* and the semantic requirements consist of *U-value* and *material*. Each of the properties is assigned to a vagueness type, maximum percentage (which is reduced with incrementing the LOD), and a flag for whether its existence is mandatory. Additionally, LOD 200 requires *Surface* geometric representation, whereas, LOD 300 requires a *BoundingBox*. Section 4 describes in detail how those requirements are applied to actual building instances.

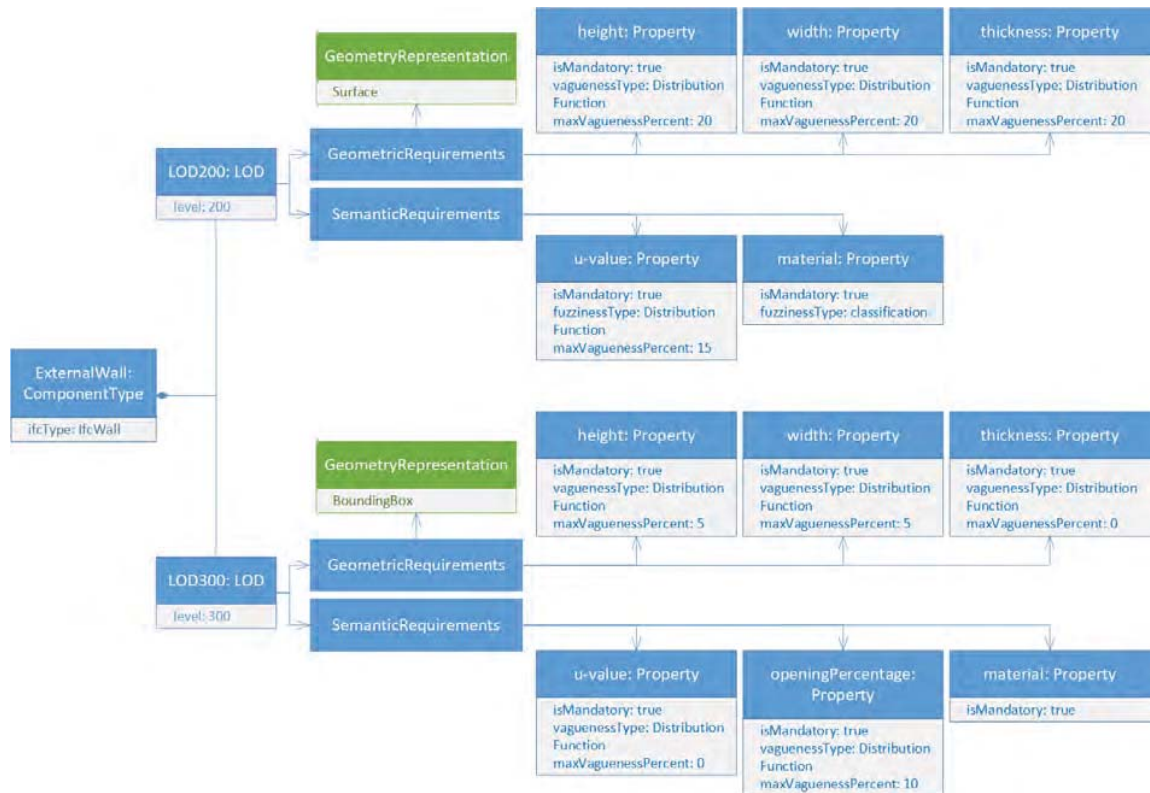

Figure 7: Demonstrating an instance of the Multi-LOD meta-model for an external wall with LOD 200 and 300 (UML diagram)

## 4. Case Study: Managing Design Variants of the Tausendpfund Building

In this case study, the proposed approaches for managing design variants were applied to a real-world construction office building (Ferdinand Tausendpfund GmbH & Co. KG, Regensburg). As depicted in Figure 8, during the design stages, two different materials for the building's external walls were evaluated in terms of energy efficiency.

After deciding on having three storeys, including their dimensions at BDL3, two variants for the façade of the building were evaluated, *load-bearing concrete* walls (Variant 1) and *curtain* walls that are made of glass (Variant 2). Thus, in case of Variant 2 is chosen, the windows are replaced by glass elements.

Figure 9 exhibits the instance level of external walls at LOD 200 and LOD 300 for Variant 2. In LOD 200, *height* and *u-value* are assigned to a probability distribution vagueness type and the maximum vagueness percentage is translated into upper and lower limits. At the same time, the *material* is assigned to *glass* while having a classification vagueness assigned to it. The classification vagueness here means that the material value can be changed within the same classification level. In LOD 300 the assigned vagueness is reduced or even omitted since a final decision regarding these properties is required to reach LOD 300.

In case of design variants, related models are imported into the Options Manager Tool and the designer decides which elements are part of the single variants. Afterwards, the related graph database is created or, respectively, expanded by newly added elements. In case of the addition or specification of information resulting from increasing LODs (e.g., a specification of material, height and u-value of the façade as shown in Figure 11), this information is linked to the related elements.

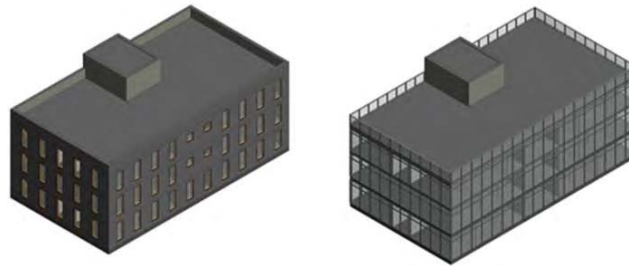

Figure 8: Variants for the Tausendpfund Office Building in Regensburg, Germany



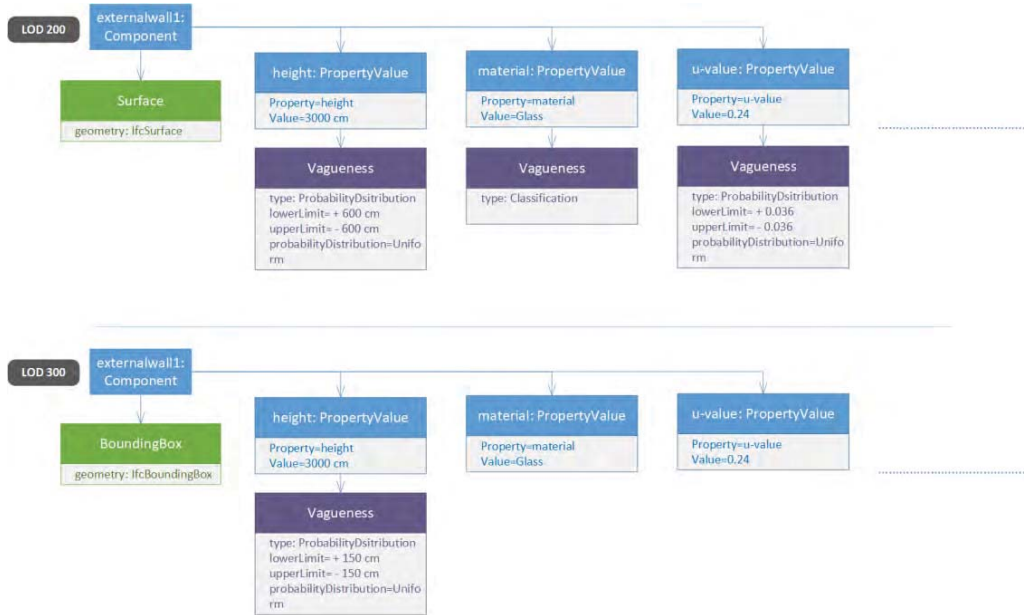

Figure 9: Assigning vagueness to an External Wall instance at LOD 200 and LOD 300

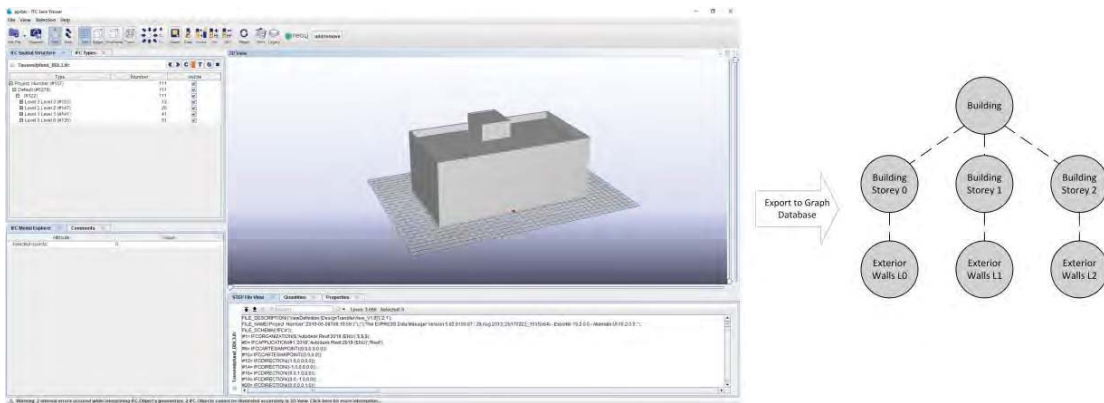

Figure 10: Representation of BDL 3 (no variants available) in the Option Manager Tool

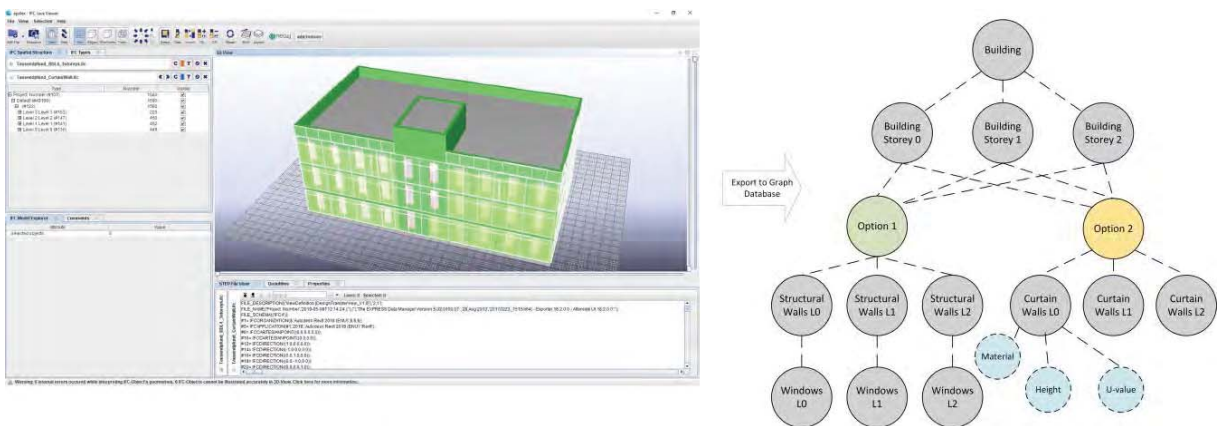

Figure 11: Representation of BDL 4 (Variants 1 and 2) in the Option Manager Tool and export to the graph database

## 5. Conclusion and Future Work

The design process of a building represents a highly individual and iterative process. Over the scope of months (or years), suitable variants are developed and detailed further until reaching the required level of planning precision. The application of BIM highly improves the potential of comparing and evaluating different designs concerning predefined boundary conditions or the stakeholder's interests. The presented concept aims at supporting the management of design variants provided at different levels of development. A case study demonstrates how the meta-model can be employed to consistently manage the formal requirements of LODs and provide information about the model maturity including its vagueness

The multi-LOD concept is combined with a variant management concept which enables to manage design variants without creating redundant information. Both concepts are based on the structure and scope of IFC 4, which offers a wide application range.

Future work includes an automated detection of invalid combinations despite of vague information.

## Acknowledgements

The authors would like to thank the Ferdinand Tausendpfund GmbH for providing their office building as a sample project and gratefully acknowledge the support of German Research Foundation (DFG) for funding the project under grant FOR 2363.

## References

- Abualdenien, J., & Borrmann, A. (2019). A meta-model approach for formal specification and consistent management of multi-LOD building models. *Advanced Engineering Informatics*, 40, 135–153. <https://doi.org/10.1016/j.aei.2019.04.003>
- Ballard, G., & Koskela, L. (1998). On the Agenda of Design Management Research. *6th Annual Conference of the International Group for Lean Construction*. Retrieved from <http://www.iglc.net/papers/details/38>
- BIMForum. (2019). 2019 Level of Development Specification Guide. Retrieved from <https://bimforum.org/wp-content/uploads/2019/04/LOD-Spec-2019-Part-I-and-Guide-2019-04-29.pdf>
- Bolpagni, M. (2016). The Many Faces of ‘LOD’. Retrieved from <https://www.bimthinkspace.com/2016/07/the-many-faces-of-lod.html>
- BuildingSMART International. (2016). *Industry Foundation Classes IFC4 Official Release*. Retrieved from <http://www.buildingsmart-tech.org/ifc/IFC4/final/html/>
- Chiu, M.-L. (2002). An organizational view of design communication in design collaboration. *Design Studies*, 23(2), 187–210. [https://doi.org/10.1016/S0142-694X\(01\)00019-9](https://doi.org/10.1016/S0142-694X(01)00019-9)
- Kolltveit, B. J., & Grønhaug, K. (2004). The importance of the early phase: The case of construction and building projects. *International Journal of Project Management*, 22(7), 545–551. <https://doi.org/10.1016/j.ijproman.2004.03.002>
- Mattern, H., & König, M. (2017). IFC-based Modeling and Management of Design Options. *Proceedings of 24th EG-ICE International Workshop on Intelligent Computing in Engineering (EG-ICE 2017)*.
- Mattern, H., & König, M. (2018). BIM-based modeling and management of design options at early planning phases. *Advanced Engineering Informatics*, 38, 316–329. <https://doi.org/10.1016/j.aei.2018.08.007>